



Post





PX-1400-NEG

Spotlight IP65 Post GU10 8W Black 370lm

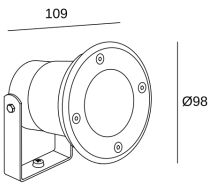

TECHNICAL FEATURES



IP65 IK09      

Total power consumption of light (W) : 8W

Real lumens : 370

Nominal lumens : 0

Real lm/W : 46

Lens / reflector angle : MEDIUM 28°

Structure material : Aluminium, Aluminium

Structure finish : Black

Diffuser material : Glass

Diffuser finish : Transparent

Max. size of light bulb : 55/50 mm

Recommended light bulb : GU10

Voltage / frequency : 100-240V/50-60Hz

Warranty : 5 Years

Easily recycled luminaire

LUMINOTECHNIC FEATURES

CRI: NA

MacAdam steps: NA

Photobiological risk: NA

Lampholder	Quantity	Light source power (W)
GU10	1	Max. power 8W

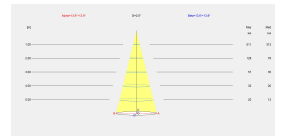
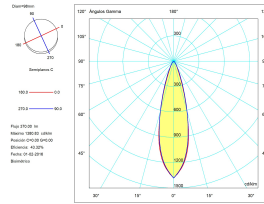

LOGISTICS

Net weight (kg): 0.47

Packaged weight (kg): 0.58

Packaging: 100mm x 100mm x 180mm





Luminaire

Code PX-1400-NEG
 Name Aplique HELIO 1x50W GU10

Measurement

Code PX-1400-NEG
 Name Aplique HELIO 1x50W GU10

Luminaire Flux	160.28 lm	Luminaire Power	100.00 W	Efficacy	1.60 lm/W	Efficiency	43.32%
Lamps Flux	370.00 lm	Maximum value	510.91 cd	Position	C=0.00 G=0.00	CG	Double Symmetrical
Round Luminaire Round Luminous Area		Diam.	98 mm	Height	98 mm		
		Diam.	50 mm	Height	10 mm		
Horizontal Luminous Area	0.001963 m2			Emitting area on Plane 180°	0.000500 m2		
Emitting area on Plane 0°	0.000500 m2			Emitting area on Plane 270°	0.000500 m2		
Emitting area on Plane 90°	0.000500 m2			Glare area at 76°	0.000960 m2		
Coordinate system	CG			Symmetry Type	Double Symmetrical		
Date	01-02-2016			Maximum Gamma Angle	90		
Measurement Distance	0.00			Measurement Flux	370.00 lm		
Operator				Source Voltage [V]			
Temperature	25.00 °C			Source current [A]			
Humidity	60.00 %			Photocell			
Notes							

Line	Code	Luminaire Lamps		Flux [lm]	Pow. [W]	Q.ty
		Name				
	64826FL	Name	64826FL - 100.00 W	370.00	100.00	1
C.I.E.	91 97 99 100 43		D DIN 5040	A60		
F UTE	0.43 A		B NBN	BZ 1		

Diam=98mm

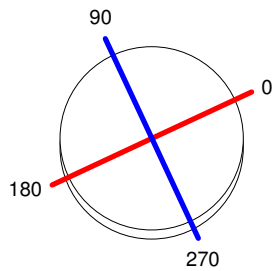

Semiplanos C



ULOR	0.00 %
DLOR	43.32 %
RN	0.00 %

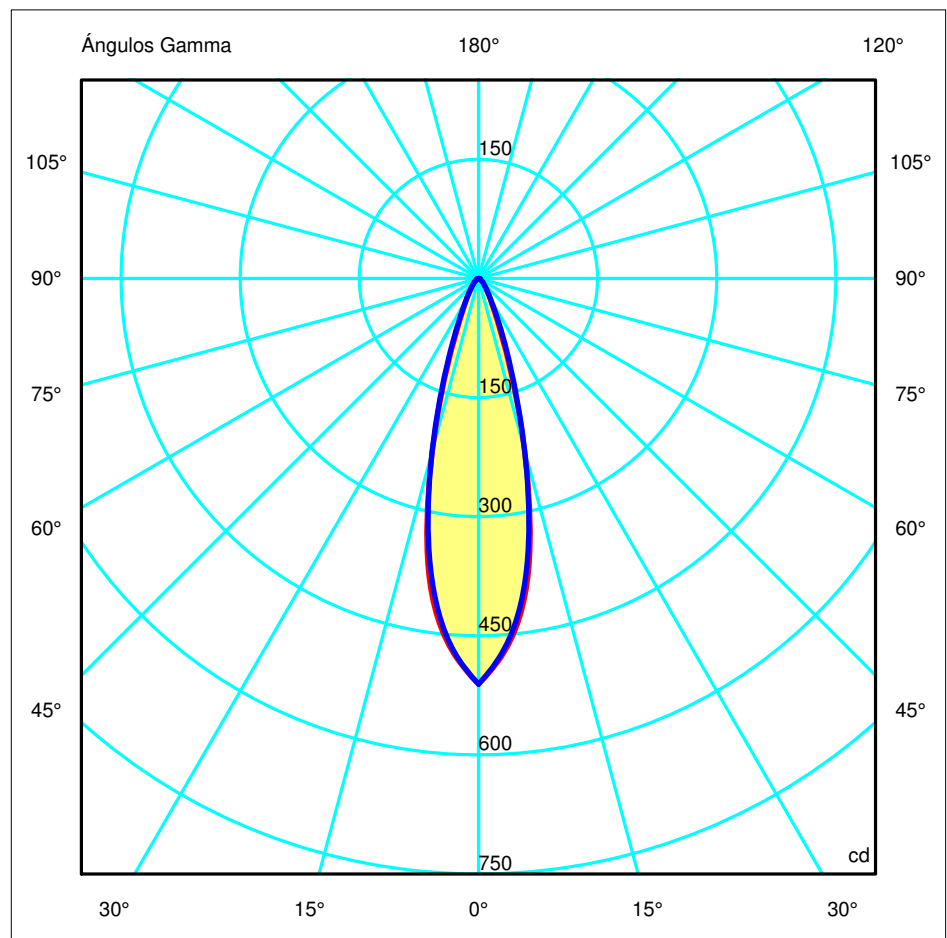

Luminaire
 Code PX-1400-NEG
 Name Aplique HELIO 1x50W GU10
Measurement.
 Code PX-1400-NEG
 Name Aplique HELIO 1x50W GU10

Luminaire Flux	160.28 lm	Luminaire Power	100.00 W	Efficacy	1.60 lm/W	Efficiency	43.32%
Lamps Flux	370.00 lm	Maximum value	510.91 cd	Position	C=0.00 G=0.00	CG	Double Symmetrical

Diam=98mm

Semiplanos C

180.0 ——— 0.0
 270.0 ——— 90.0

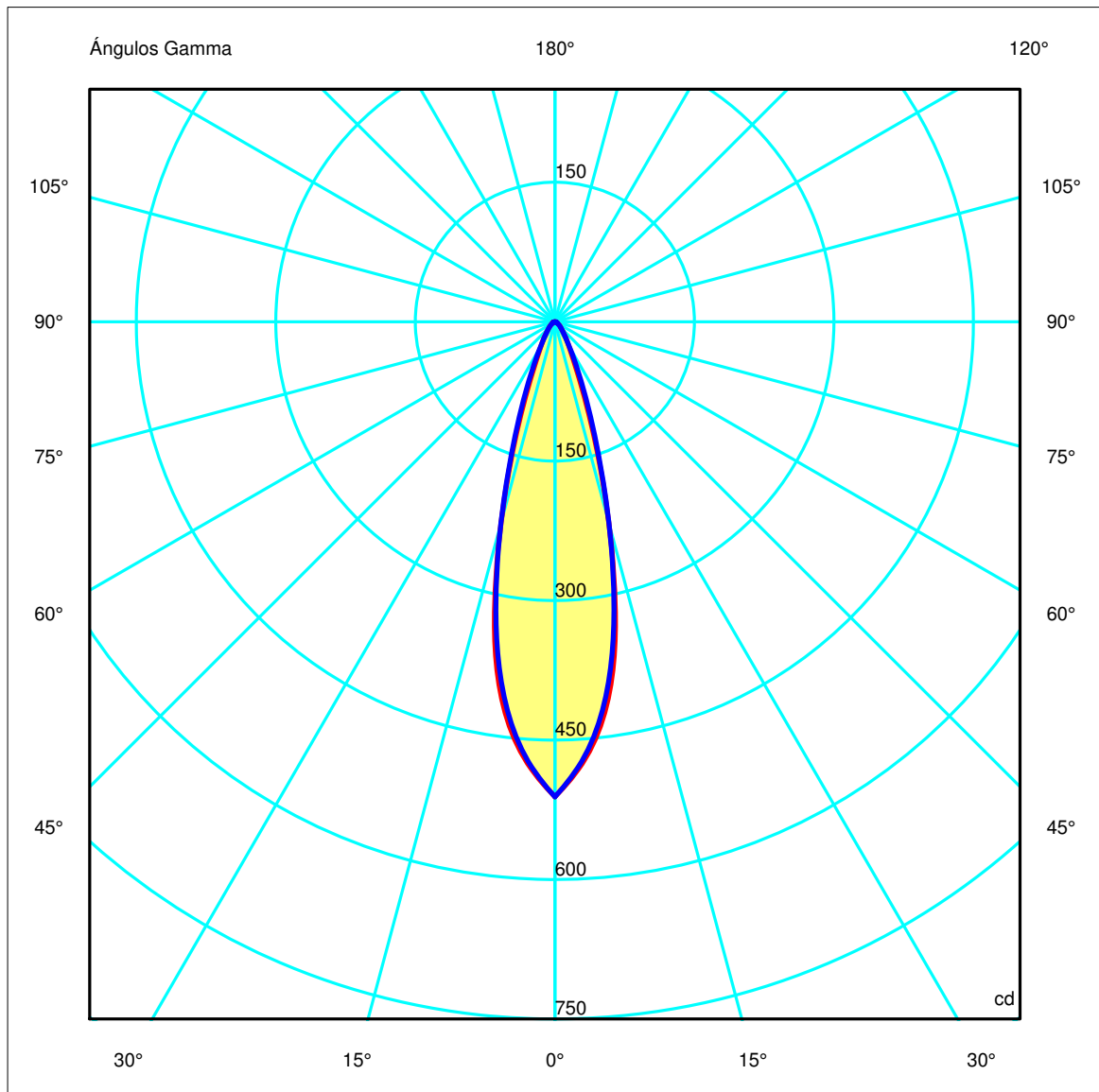
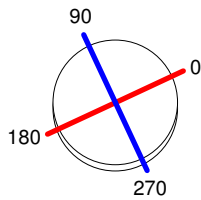

Luminaire

Code PX-1400-NEG
Name Aplique HELIO 1x50W GU10

Measur.

Code PX-1400-NEG
Name Aplique HELIO 1x50W GU10

Luminaire Flux	160.28 lm	Luminaire Power	100.00 W	Efficacy	1.60 lm/W	Efficiency	43.32%
Lamps Flux	370.00 lm	Maximum value	510.91 cd	Position	C=0.00 G=0.00	CG	Double Symmetrical

Width at 50.00 % of Max Intensity

H[m]	1.00	2.00	3.00	4.00	5.00	H[m]	1.00	2.00	3.00	4.00	5.00
OA	0.25	0.50	0.74	0.99	1.24	OC	0.25	0.49	0.74	0.98	1.23
OB	0.25	0.50	0.74	0.99	1.24	OD	0.25	0.49	0.74	0.98	1.23

		Luminous Intensities [cd]									
	0	5	15	25	35	45	55	65	75	85	
OA	510.91	458.24	223.92	50.37	19.27	8.89	3.98	2.62	1.61	0.78	
OB	510.91	458.24	223.92	50.37	19.27	8.89	3.98	2.62	1.61	0.78	
OC	510.91	453.48	224.45	59.94	18.80	8.99	4.57	2.49	1.51	0.75	
OD	510.91	453.48	224.45	59.94	18.80	8.99	4.57	2.49	1.51	0.75	

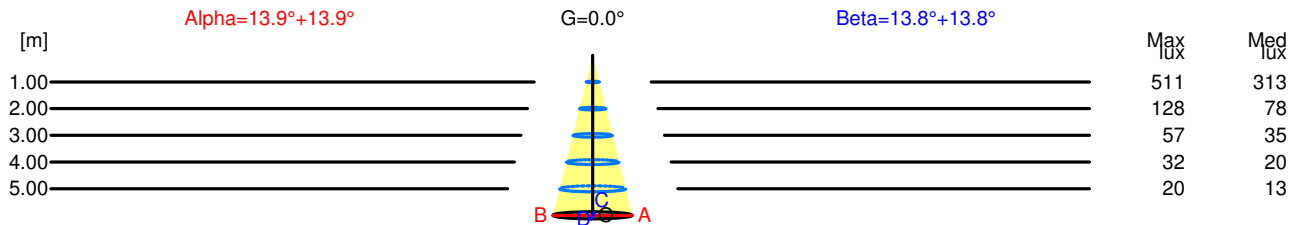

H[m]	D[m]	Max lux	Med lux	Alpha=13.9°+13.9°	G=0.0
1.00	0.50	511	313		
2.00	0.99	128	78		
3.00	1.49	57	35		
4.00	1.98	32	20		
5.00	2.48	20	13		

H[m]	D[m]	Max lux	Med lux	Beta=13.8°+13.8°	G=0.0
1.00	0.49	511	313		
2.00	0.98	128	78		
3.00	1.48	57	35		
4.00	1.97	32	20		
5.00	2.46	20	13		

Luminaire
 Code PX-1400-NEG
 Name Aplique HELIO 1x50W GU10
Measurement
 Code PX-1400-NEG
 Name Aplique HELIO 1x50W GU10

Luminaire Flux	160.28 lm	Luminaire Power	100.00 W	Efficacy	1.60 lm/W	Efficiency	43.32%
Lamps Flux	370.00 lm	Maximum value	510.91 cd	Position	C=0.00 G=0.00	CG	Double Symmetrical

Isolux (Floor)

Luminaire position X=0.00m Y=0.00m Z=2.50m

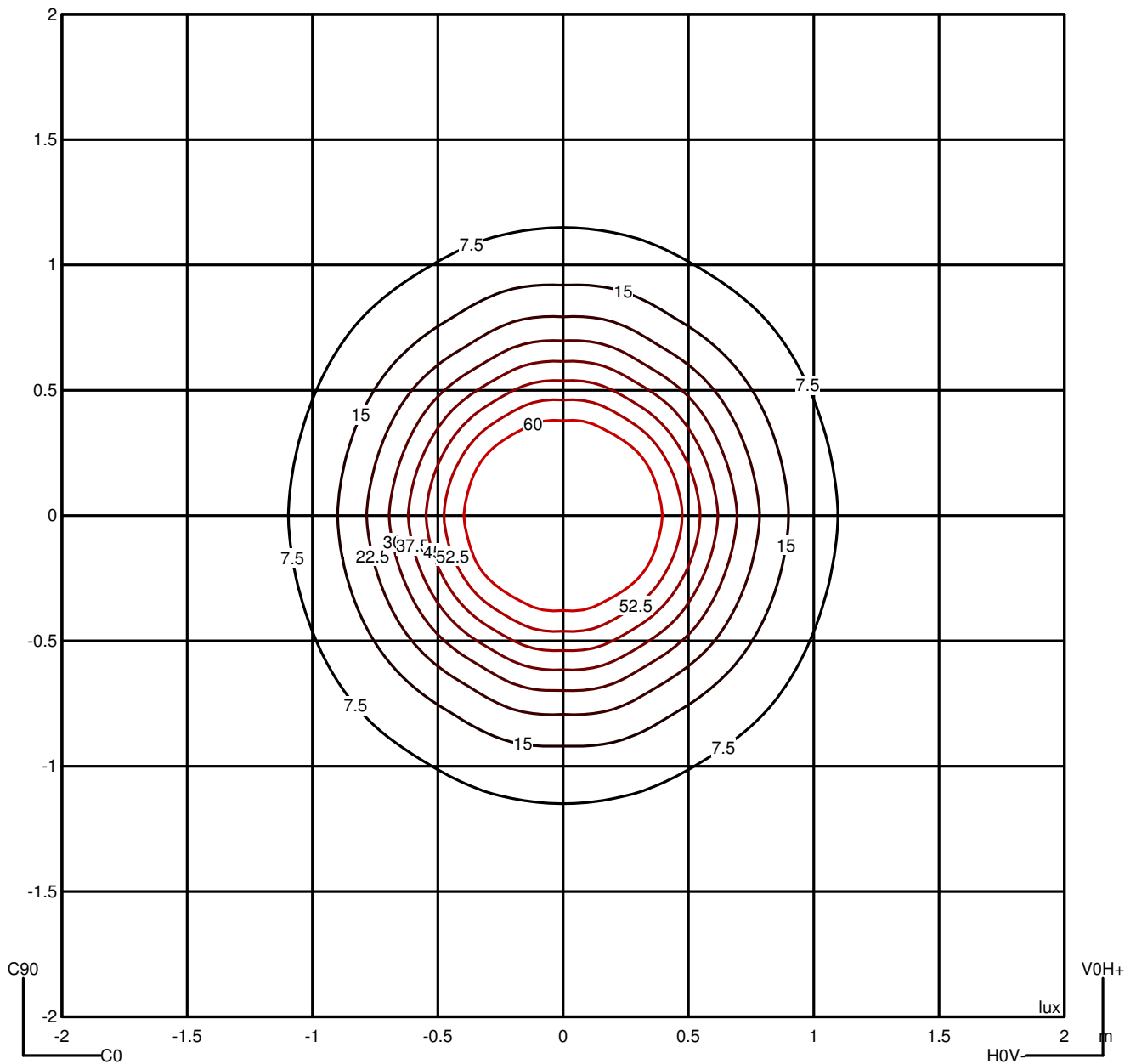

Luminaire
 Code PX-1400-NEG
 Name Aplique HELIO 1x50W GU10
Measurement.
 Code PX-1400-NEG
 Name Aplique HELIO 1x50W GU10

Luminaire Flux	160.28 lm	Luminaire Power	100.00 W	Efficacy	1.60 lm/W	Efficiency	43.32%
Lamps Flux	370.00 lm	Maximum value	510.91 cd	Position	C=0.00 G=0.00	CG	Double Symmetrical

		Average Luminance [cd/m ²]									
		45°	50°	55°	60°	65°	70°	75°	80°	85°	
0.0°		5102	4179	2591	2108	2044	1875	1624	1404	1171	---
90.0°		5159	3664	2973	2021	1940	1767	1527	1335	1125	---

Flujo montado o vista longitudinal												
		Iluminancia (lx)										
A	A	2000	1000	750	500		<300					1.15
B	1		2000	1500	1000	750	500	<300				1.5
C					2000		1000	500	<300			1.85
D	2						2000	1000	500	<300		2.2
E	3							2000	1000	500	<300	2.55

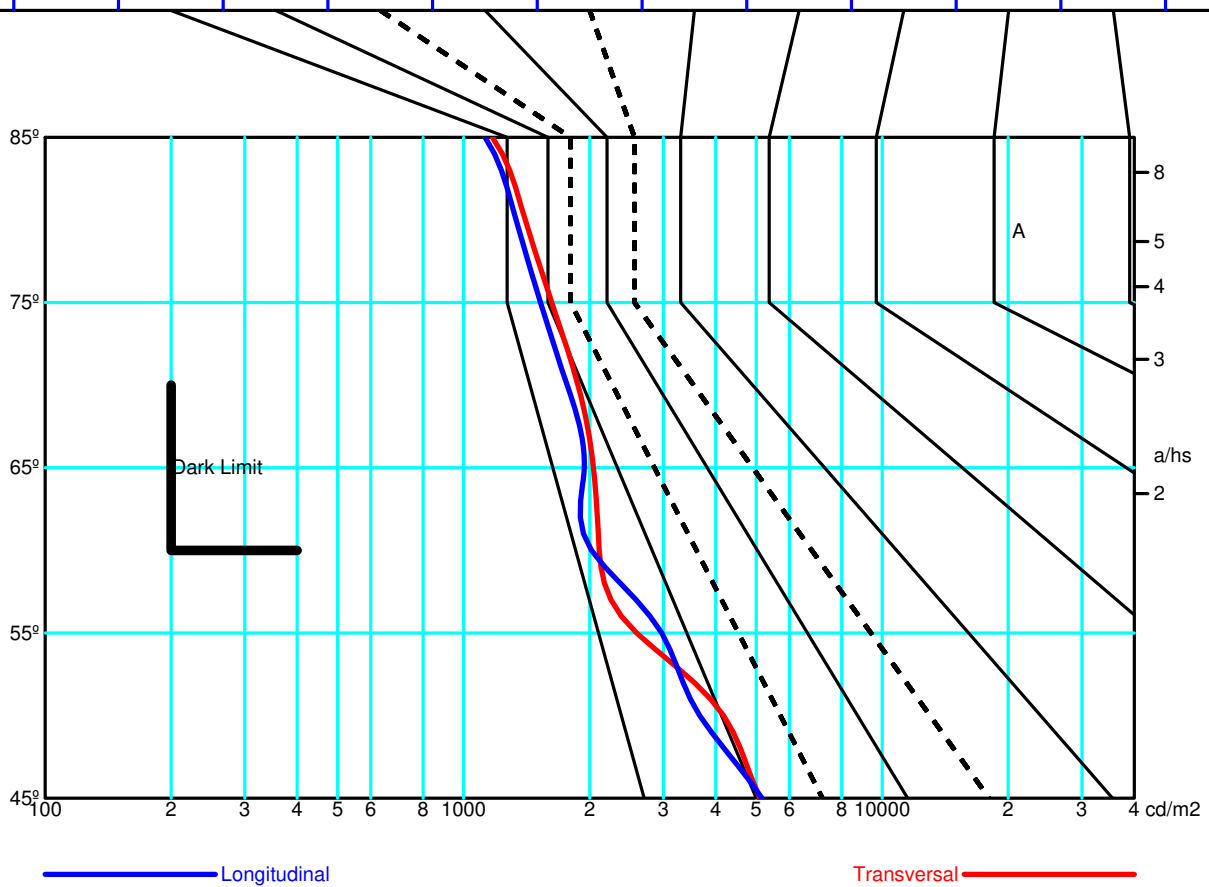

Luminaire

Code PX-1400-NEG
 Name Applique HELIO 1x50W GU10

Measurement

Code PX-1400-NEG
 Name Applique HELIO 1x50W GU10

Luminaire Flux	160.28 lm	Luminaire Power	100.00 W	Efficacy	1.60 lm/W	Efficiency	43.32%
Lamps Flux	370.00 lm	Maximum value	510.91 cd	Position	C=0.00 G=0.00	CG	Double Symmetrical

Diam=98mm

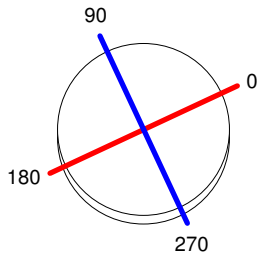

Semiplanos C

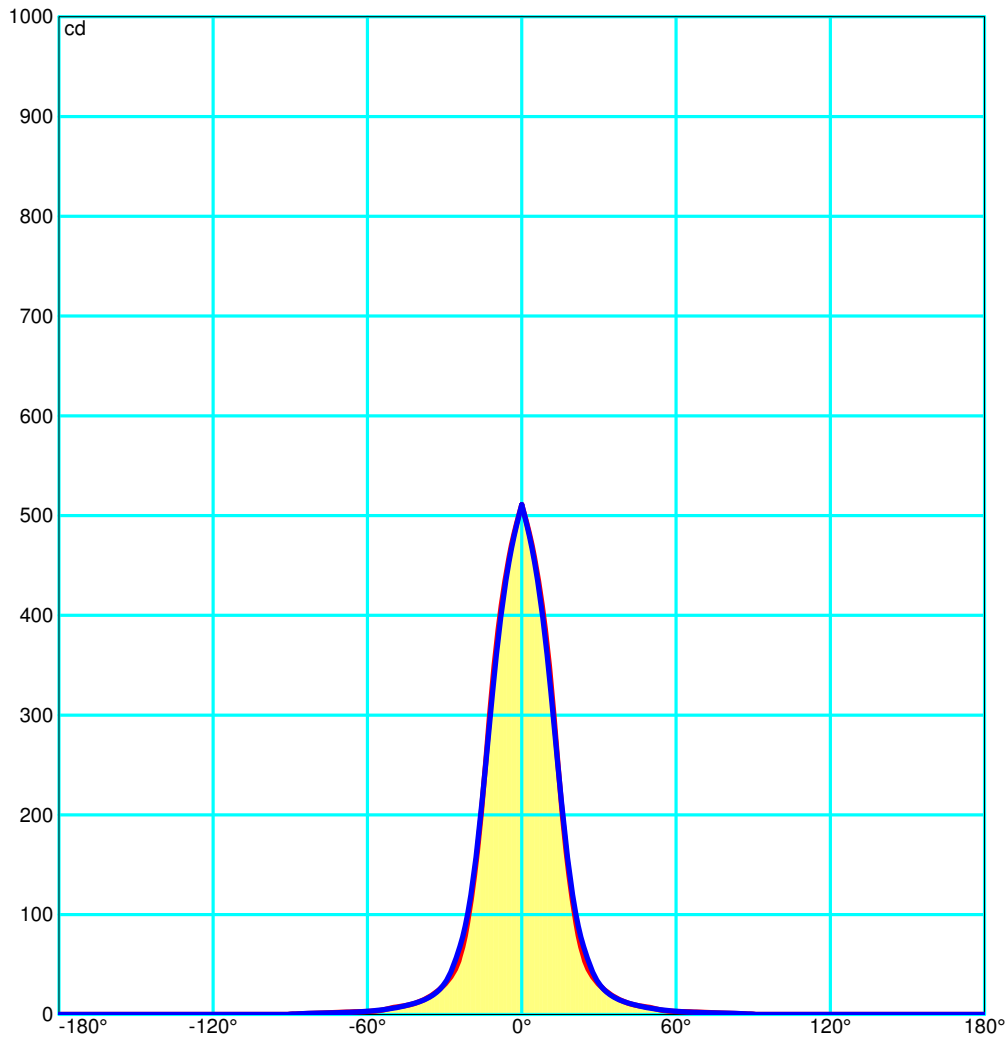

Luminaire

 Code PX-1400-NEG
 Name Aplique HELIO 1x50W GU10

Measurement

 Code PX-1400-NEG
 Name Aplique HELIO 1x50W GU10

Luminaire Flux	160.28 lm	Luminaire Power	100.00 W	Efficacy	1.60 lm/W	Efficiency	43.32%
Lamps Flux	370.00 lm	Maximum value	510.91 cd	Position	C=0.00 G=0.00	CG	Double Symmetrical

UGR
S = 0.250

Reflectancies										
Ceiling/Cavity	0.7	0.7	0.5	0.5	0.3	0.7	0.7	0.5	0.5	0.3
Walls	0.5	0.3	0.5	0.3	0.3	0.5	0.3	0.5	0.3	0.3
WorkingPlane	0.2	0.2	0.2	0.2	0.2	0.2	0.2	0.2	0.2	0.2
RoomDimensions	ViewedCrosswise					ViewedEndwise				
x=2H y=2H	11.4	12.1	11.6	12.3	12.6	11.4	12.2	11.7	12.4	12.6
x=2H y=3H	12.1	12.8	12.4	13.1	13.3	12.1	12.8	12.4	13.1	13.3
x=2H y=4H	12.5	13.1	12.8	13.4	13.6	12.4	13.1	12.7	13.3	13.6
x=2H y=6H	12.8	13.4	13.1	13.7	13.9	12.7	13.3	13.0	13.6	13.9
x=2H y=8H	12.9	13.5	13.2	13.8	14.0	12.8	13.4	13.1	13.7	14.0
x=2H y=12H	13.0	13.6	13.4	13.9	14.1	12.9	13.5	13.3	13.8	14.1
x=4H y=2H	11.7	12.3	12.0	12.6	12.9	11.7	12.4	12.0	12.6	12.9
x=4H y=3H	12.7	13.2	13.0	13.5	13.8	12.6	13.2	13.0	13.5	13.8
x=4H y=4H	13.2	13.6	13.6	14.0	14.2	13.1	13.6	13.5	13.9	14.2
x=4H y=6H	13.6	14.0	14.0	14.4	14.7	13.5	13.9	13.9	14.3	14.7
x=4H y=8H	13.8	14.2	14.2	14.5	14.8	13.7	14.1	14.1	14.4	14.8
x=4H y=12H	14.0	14.3	14.4	14.7	15.0	13.9	14.2	14.3	14.6	15.0
x=8H y=4H	13.4	13.8	13.8	14.1	14.5	13.3	13.7	13.8	14.1	14.5
x=8H y=6H	14.0	14.2	14.4	14.7	15.0	13.9	14.1	14.3	14.6	15.0
x=8H y=8H	14.2	14.5	14.7	14.9	15.3	14.1	14.3	14.6	14.8	15.3
x=8H y=12H	14.5	14.7	15.0	15.2	15.5	14.4	14.6	14.9	15.0	15.5
x=12H y=4H	13.4	13.7	13.8	14.1	14.5	13.3	13.6	13.7	14.0	14.5
x=12H y=6H	14.0	14.2	14.5	14.7	15.1	13.9	14.1	14.4	14.6	15.1
x=12H y=8H	14.3	14.5	14.8	15.0	15.4	14.2	14.4	14.7	14.9	15.4

Luminaire

Code PX-1400-NEG
Name Aplique HELIO 1x50W GU10

Measurment

Code PX-1400-NEG
Name Aplique HELIO 1x50W GU10

Luminaire Flux	160.28 lm	Luminaire Power	100.00 W	Efficacy	1.60 lm/W	Efficiency	43.32%
Lamps Flux	370.00 lm	Maximum value	510.91 cd	Position	C=0.00 G=0.00	CG	Double Symmetrical

Flujo Total=370.00 Flujo Luminaria=160.28

RI	0.60	0.80	1.00	1.25	1.50	2.00	2.50	3.00	4.00	5.00	10.00	20.00
DRR	0.66	0.71	0.77	0.81	0.84	0.89	0.92	0.94	0.96	0.98	1.00	1.01
RC	-	-	-	-	-	-	-	-	-	-	-	-

Flujo Zonal por 1000 Lúmenes

Y°	10	20	30	40	50	60	70	80	90	100	110	120	130	140	150	160	170	180
ZF(Y)	110	278	354	389	408	419	426	431	433	433	433	433	433	433	433	433	433	433

Códigos de Flujo C.I.E.
91 97 99 100 43

C.I.E.	-/-/-/-/-/-/-/-/-/-	LOR	43.31802 %
D DIN 5040	A60	ULOR	0.00000 %
F UTE	0.43 A	DLOR	43.31802 %
B NBN	BZ 1	UFF	0.00000 %
RN	0.00000 %	DFF	100.00000 %
BLF	1.0	FFR	0.00000 %

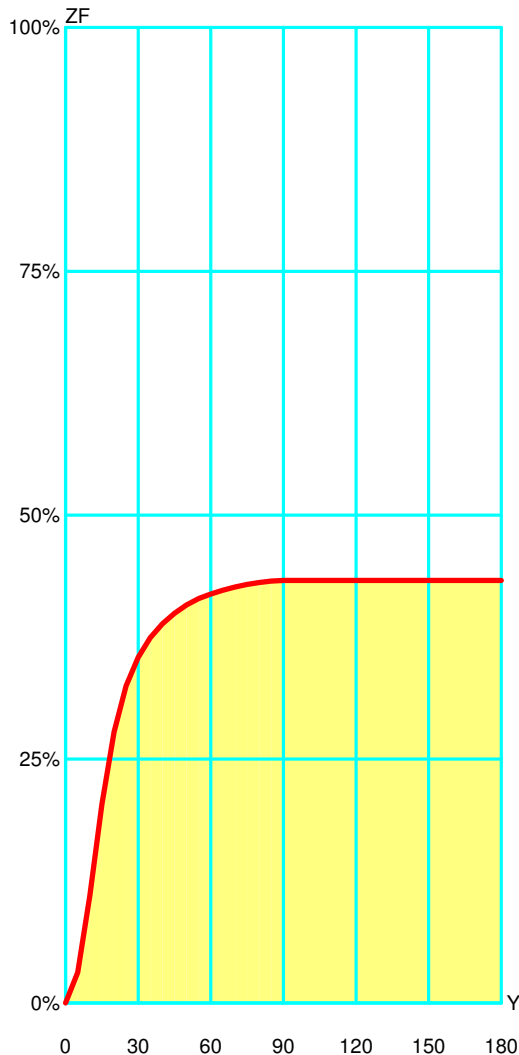

Gamma °	Flujo Zonal			
	Flujo	Suma lm	Flujo [%]	Suma [%]
0°	0.00	0.00	0.00%	0.00 %
5°	31.29	31.29	7.22 %	7.22 %
10°	79.10	110.39	18.26 %	25.48 %
15°	93.18	203.58	21.51 %	47.00 %
20°	74.13	277.71	17.11 %	64.11 %
25°	47.28	324.98	10.91 %	75.02 %
30°	29.38	354.37	6.78 %	81.81 %
35°	20.00	374.37	4.62 %	86.42 %
40°	14.33	388.69	3.31 %	89.73 %
45°	10.80	399.49	2.49 %	92.22 %
50°	8.50	407.99	1.96 %	94.18 %
55°	6.52	414.51	1.51 %	95.69 %
60°	4.72	419.23	1.09 %	96.78 %
65°	3.81	423.04	0.88 %	97.66 %
70°	3.33	426.36	0.77 %	98.43 %
75°	2.65	429.01	0.61 %	99.04 %
80°	1.98	430.99	0.46 %	99.49 %
85°	1.42	432.41	0.33 %	99.82 %
90°	0.77	433.18	0.18 %	100.00 %
95°	0.00	433.18	0.00 %	100.00 %
100°	0.00	433.18	0.00 %	100.00 %
105°	0.00	433.18	0.00 %	100.00 %
110°	0.00	433.18	0.00 %	100.00 %
115°	0.00	433.18	0.00 %	100.00 %
120°	0.00	433.18	0.00 %	100.00 %
125°	0.00	433.18	0.00 %	100.00 %
130°	0.00	433.18	0.00 %	100.00 %
135°	0.00	433.18	0.00 %	100.00 %
140°	0.00	433.18	0.00 %	100.00 %
145°	0.00	433.18	0.00 %	100.00 %
150°	0.00	433.18	0.00 %	100.00 %
155°	0.00	433.18	0.00 %	100.00 %
160°	0.00	433.18	0.00 %	100.00 %
165°	0.00	433.18	0.00 %	100.00 %
170°	0.00	433.18	0.00 %	100.00 %
175°	0.00	433.18	0.00 %	100.00 %
180°	0.00	433.18	0.00 %	100.00 %

Luminaire

Code PX-1400-NEG
 Name Aplique HELIO 1x50W GU10

Measurment

Code PX-1400-NEG
 Name Aplique HELIO 1x50W GU10

Luminaire Flux	160.28 lm	Luminaire Power	100.00 W	Efficacy	1.60 lm/W	Efficiency	43.32%
Lamps Flux	370.00 lm	Maximum value	510.91 cd	Position	C=0.00 G=0.00	CG	Double Symmetrical

Pavement			Road		
Piano	0	0.00%	Piano	0	0.00%
Piano	-5	6.13%	Piano	5	6.13%
Piano	-10	11.29%	Piano	10	11.29%
Piano	-15	14.98%	Piano	15	14.98%
Piano	-20	17.26%	Piano	20	17.26%
Piano	-25	18.62%	Piano	25	18.62%
Piano	-30	19.46%	Piano	30	19.46%
Piano	-35	20.02%	Piano	35	20.02%
Piano	-40	20.42%	Piano	40	20.42%
Piano	-45	20.73%	Piano	45	20.73%
Piano	-50	20.96%	Piano	50	20.96%
Piano	-55	21.13%	Piano	55	21.13%
Piano	-60	21.27%	Piano	60	21.27%
Piano	-65	21.38%	Piano	65	21.38%
Piano	-70	21.47%	Piano	70	21.47%
Piano	-75	21.54%	Piano	75	21.54%
Piano	-80	21.60%	Piano	80	21.60%
Piano	-85	21.64%	Piano	85	21.64%
Piano	-90	21.66%	Piano	90	21.66%

Ángulo de Inclinación = 0.0

DLOR = 43.32%

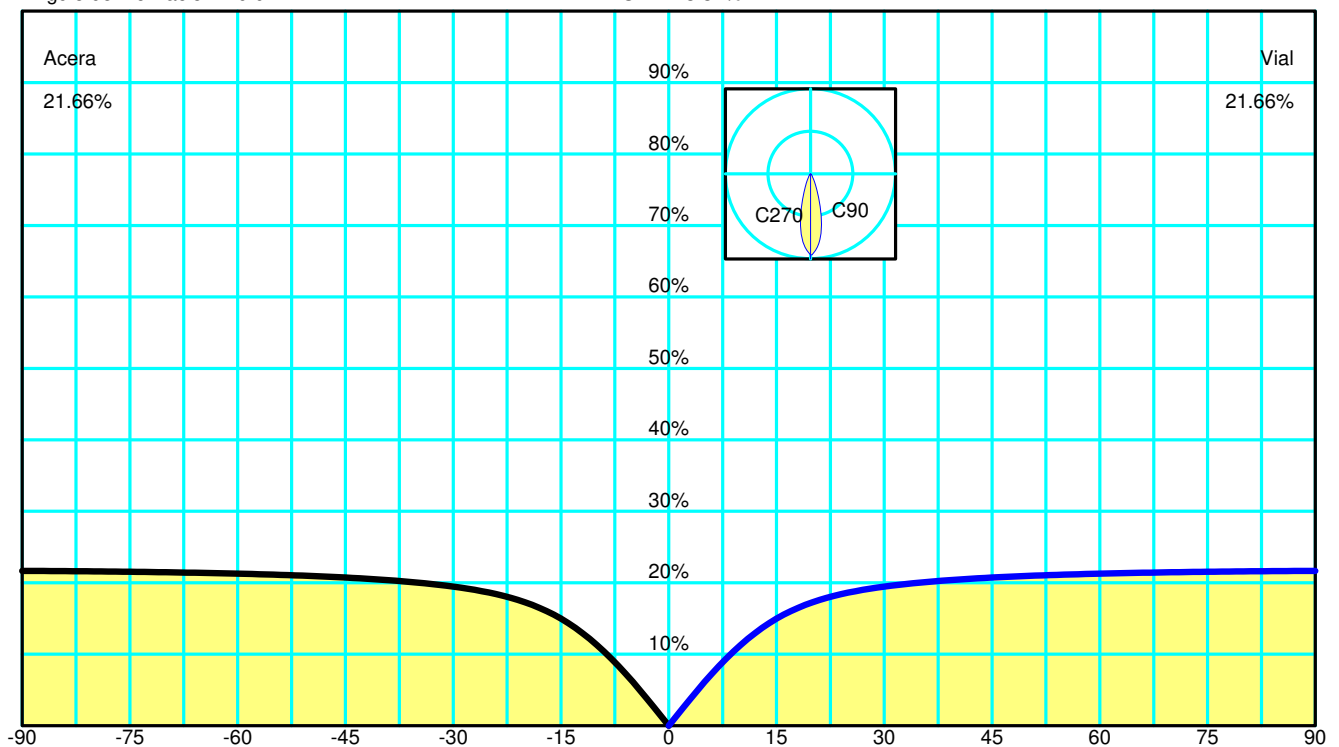

Spread	4.7° Estrecho	DLOR	43.31802 %
Throw	2.4° Corto	ULOR	0.00000 %
SLI (deslumbramiento)	Concentrado	Rendimiento	43.31802 %
Cutoff CIE	Cutoff - Max: C=0.0° Gamma=0.0°	RN	0.00000 %
Cutoff lesna	Cutoff	Clase de Intensidad Luminosa	G5
DIN5044	KB1	Índice de Deslumbramiento	D6

IESNA Type V Very Short Quadrilateral Symmetry

Luminaire
 Code PX-1400-NEG
 Name Aplique HELIO 1x50W GU10
Measurment.
 Code PX-1400-NEG
 Name Aplique HELIO 1x50W GU10

Luminaire Flux	160.28 lm	Luminaire Power	100.00 W	Efficacy	1.60 lm/W	Efficiency	43.32%
Lamps Flux	370.00 lm	Maximum value	510.91 cd	Position	C=0.00 G=0.00	CG	Double Symmetrical

US ROAD STANDARDS

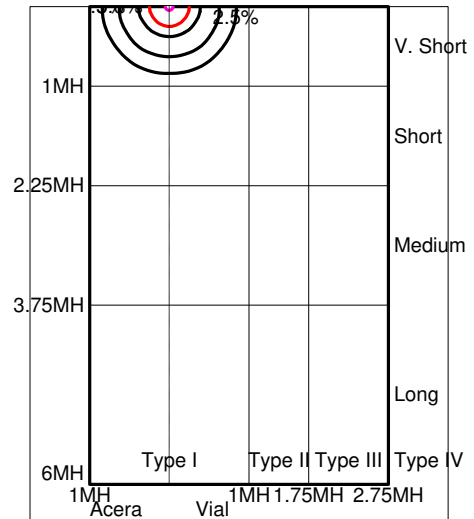
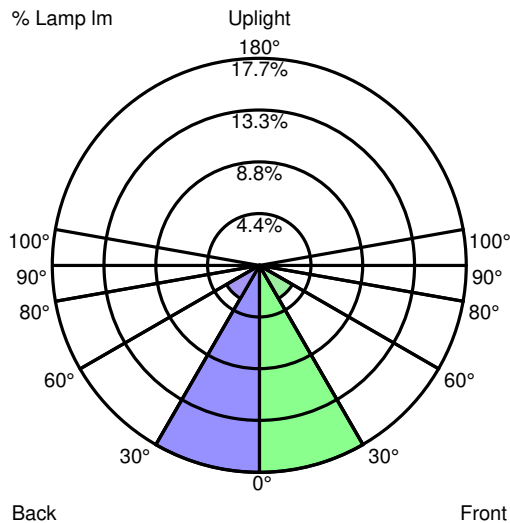

Luminaire Classification System (LCS)				
LCS Zone		Lumens	%Lamp	%Lum
FL	0° -- 30°	65.4 lm	17.7 %	40.8 %
FM	30° -- 60°	12.0 lm	3.3 %	7.5 %
FH	60° -- 80°	2.2 lm	0.6 %	1.4 %
FVH	80° -- 90°	0.4 lm	0.1 %	0.3 %
BL	0° -- 30°	65.4 lm	17.7 %	40.8 %
BM	30° -- 60°	12.0 lm	3.3 %	7.5 %
BH	60° -- 80°	2.2 lm	0.6 %	1.4 %
BVH	80° -- 90°	0.4 lm	0.1 %	0.3 %
UL	90° -- 100°	0.0 lm	0.0 %	0.0 %
UH	100° -- 180°	0.0 lm	0.0 %	0.0 %
TOTALS		160.3 lm	43.3 %	100.0 %
BUG B0 U0 G0 Type V Very Short Quadrilateral Symmetry				

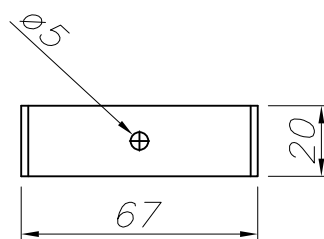
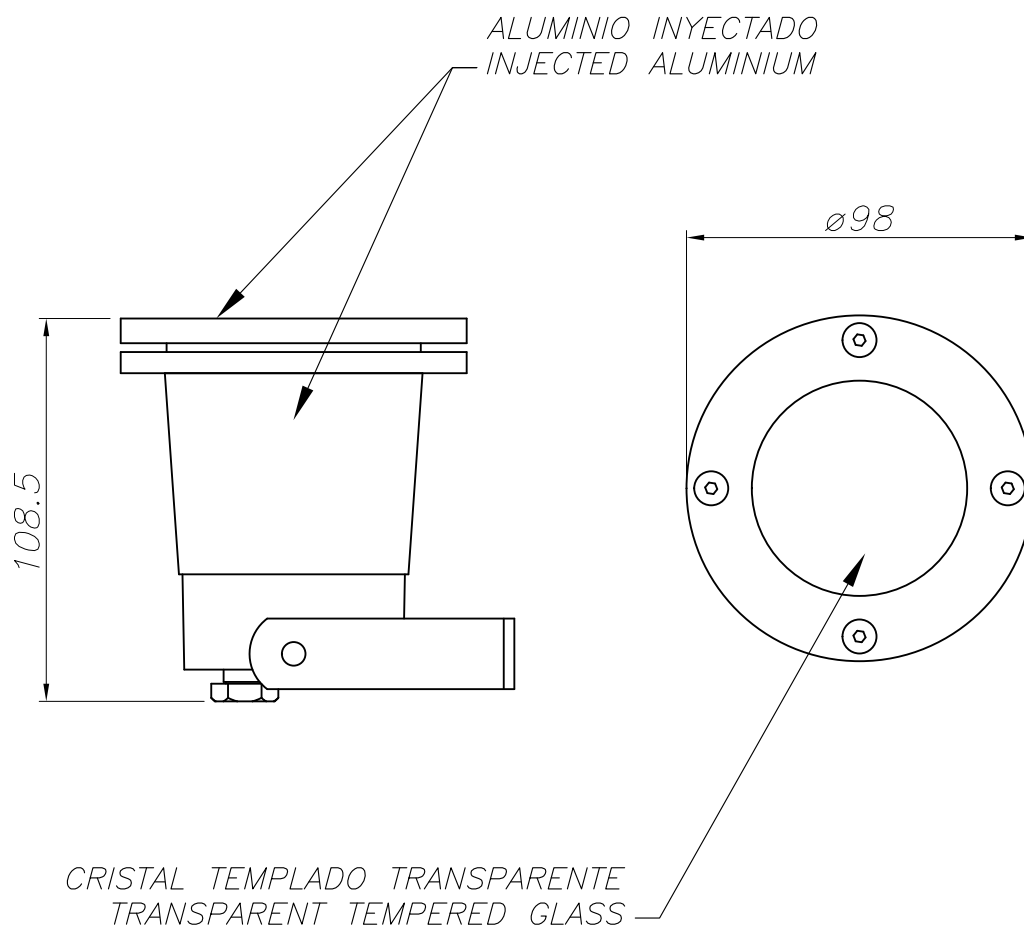

PLANTILLA DE INSTALACIÓN
INSTALLATION TEMPLATE

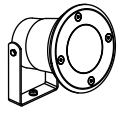

Post PX-1400

FOR
LIGHT

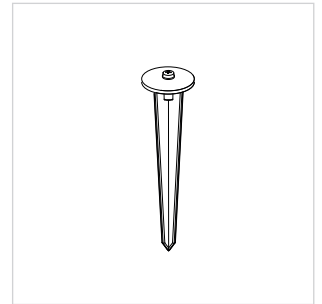
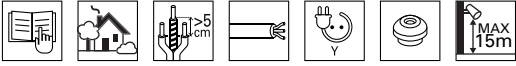

1

2

3

$\varnothing_{\min} = 5\text{mm}$
 $\varnothing_{\max} = 7\text{mm}$

L = L
N = N

4

5

GU10

6

7

8

ON

